



PL	INSTRUKCJA MONTAŻU	Nazwa	Donica Terra z pojemnikiem, wysoka	Nr kat.	58405
ENG	ASSEMBLY INSTRUCTIONS	Product	Terra Planter with container, high	Cat. no.	
DEU	MONTAGEANLEITUNG	Name	Terra Blumentopf, maxi	Art.-Nr.	

## 58405



Wiek użytkowników Age of users Altersgruppe	Ilość użytkowników Number of users Anzahl der Benutzer	Przeznaczenie urządzenia Purpose of device Bestimmung des Spielgerätes	Zgodność z normą In accordance with the standard Geltende Norm
1-7	2	do zabawy na zewnątrz for outdoor playing zum draußen Spielen	EN 71
NOVUM Sp. z o.o. ul. Gnieźnieńska 2a, 12-100 Szczytno		e-mail: kontakt@novum4kids.pl e-mail: export@novum4kids.com	www.novum4kids.pl www.novum4kids.com

**UWAGA / WARNING / ACHTUNG:**

**PL** Jeżeli w zestawie występuje zjeżdżalnia, zestaw należy posadowić w taki sposób, aby ślizg zjeżdżalni znajdował się od strony północnej, czyli od strony nienasłonecznionej, aby zapobiegać nadmiernemu nagrzewaniu się ślizgu.

**ENG** If there is a slide in the set, it should be installed from the north, poorly sunny side to avoid possible hazards (burns) through direct skin contact.

**DEU** Wenn eine Spielplatzanlage eine Rutsche enthält, sollte diese Anlage so platziert werden, dass die Rutsche sich auf der Nordseite befindet, dh. auf der schattigen Seite, um übermäßige Erwärmung der Rutschbahn zu vermeiden.

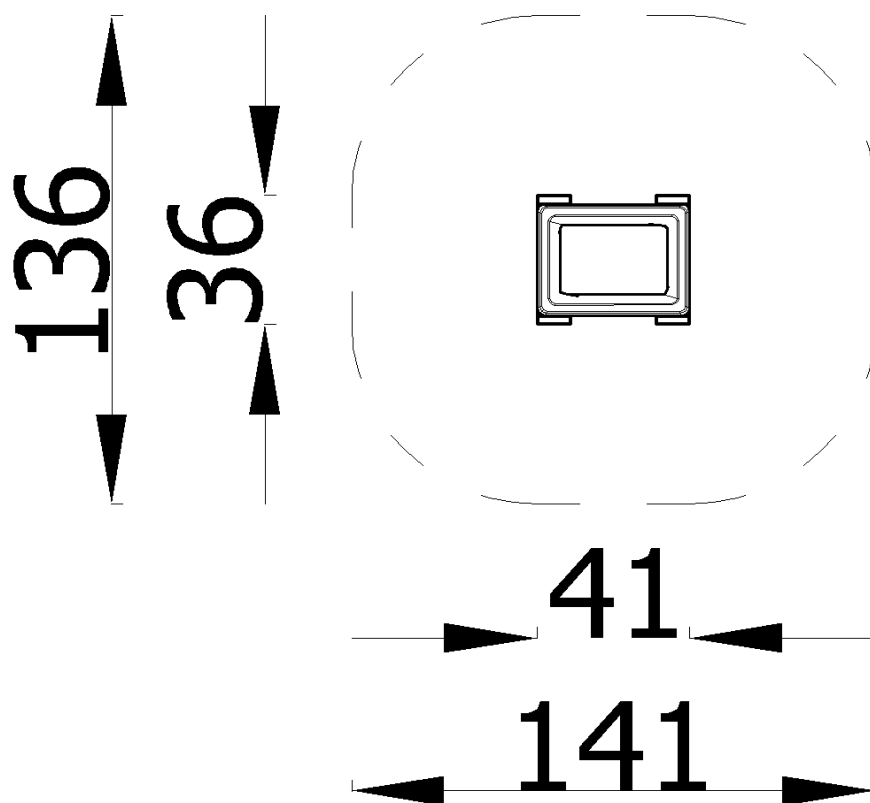

Montaż zgodnie z planem zagospodarowania terenu.  
 Installation in accordance with the land development plan.  
 Montage gemäß dem Flächennutzungsplan

Bezpieczna nawierzchnia / Safe surface / Safe Oberfläche

Strefa Zone Zone	Max. wysokość upadku Max. fall height Max. Fallhöhe	Pole powierzchni Surface area Fläche	Obwód strefy bezpiecz. Perimeter security zone Umkreis der Fallschutzfläche
A	-	1,70 m <sup>2</sup>	4,70 m
B	-	-	
C	-	-	

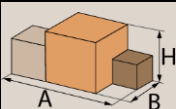
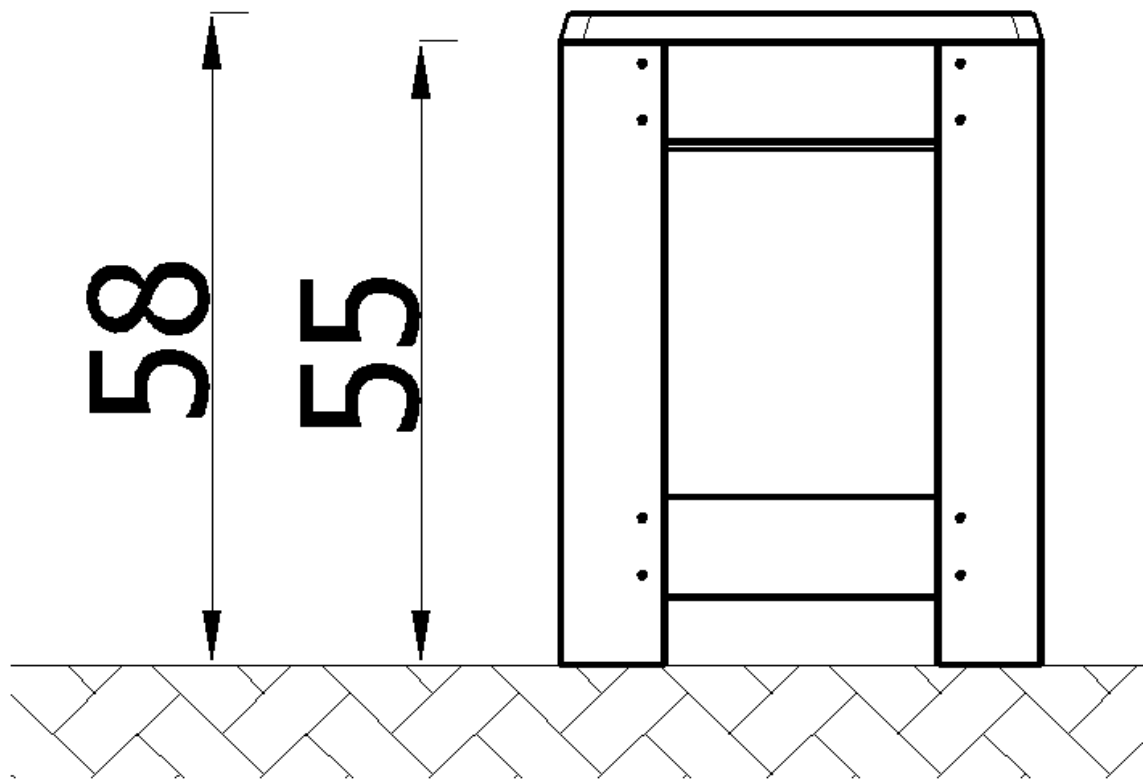

0,41x0,36x  
0,58  
(AxBxH) [m]



8,5 kg

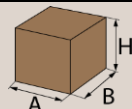

0,55x0,09x  
0,03  
(AxBxH) [m]



1 kg

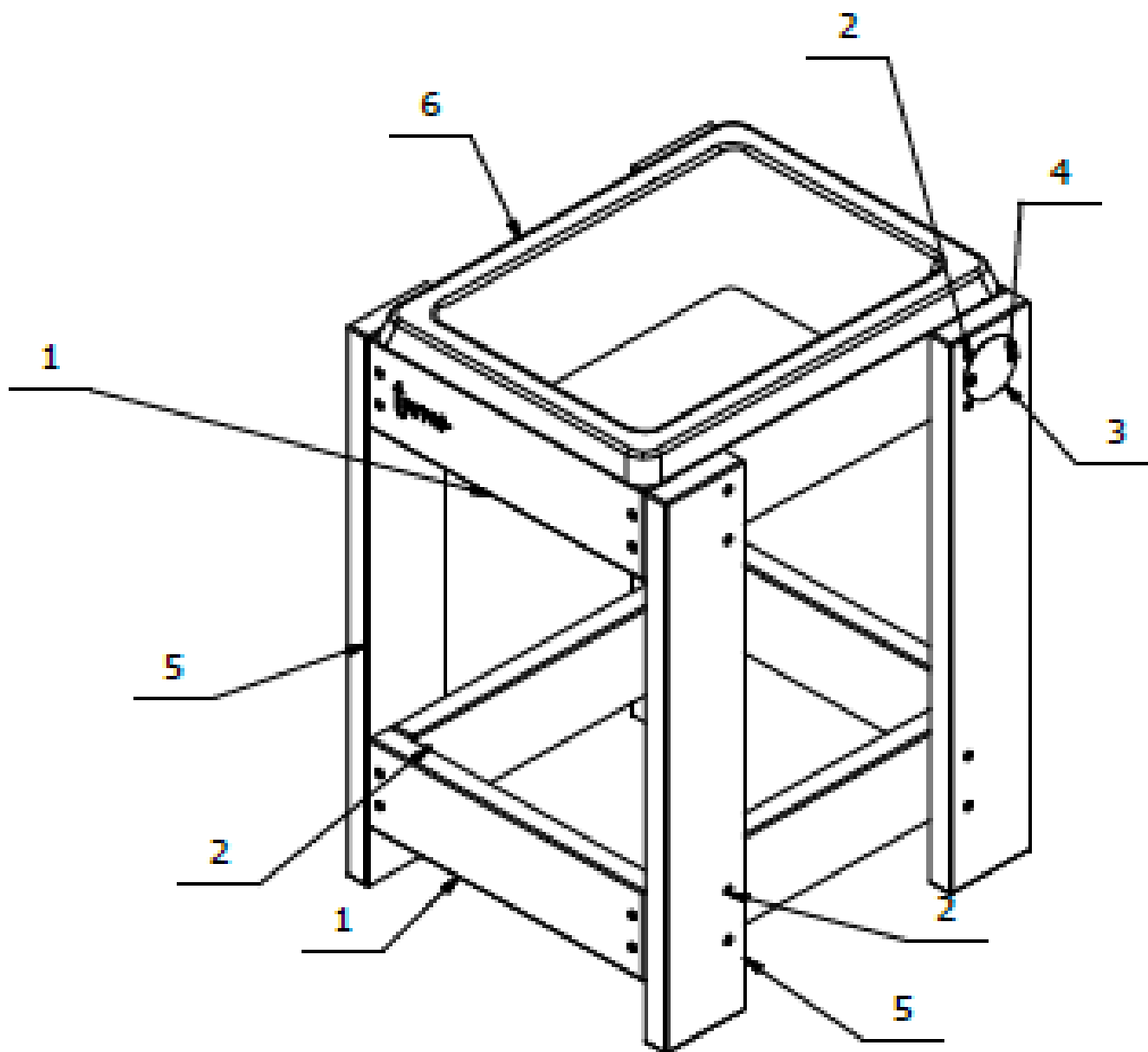













Części zamienne dostępne u producenta.  
Stosować klej do gwintów w połączeniach śrubowych.

Spare parts available from the manufacturer.  
Use thread glue in screw connections.

Ersatzteile beim Hersteller erhältlich.  
Gewindekleber für Schraubverbindungen verwenden.

6	LEK23435	1
5	DSK_58405_001	4
4	DIN7996 4x18_A2	2
3	8918_006	1
2	8905_463_5x40_A2	32
1	58403_001	2
Lp. No.	Nr części Art. Nr. Part No.	Ilość Quantity Anzahl

			
		5 m    30 m	
			
2,5 m	60 cm    100 cm		
			
	7 mm		13 mm    17 mm    19 mm    24 mm
			
13 mm    17 mm    19 mm    24 mm	4 mm    5 mm    6 mm    8 mm	T40	T45
			

8905_463_5x40_A2	32
Drawing/Norm number	Quantity

