



PL	INSTRUKCJA MONTAŻU	Nazwa	Robak Robinio	Nr kat.	30111
ENG	ASSEMBLY INSTRUCTIONS	Product		Cat. no.	
DEU	MONTAGEANLEITUNG	Name		Art.-Nr.	
FRA	INSTRUCTIONS D'INSTALLATION	Catégorie		Référence.	

**30111**



Wiek użytkowników Age of users Altersgruppe	Ilość użytkowników Number of users Anzahl der Benutzer Nombre d'utilisateurs	Przeznaczenie urządzenia Purpose of device Bestimmung des Spielgerätes	Zgodność z normą In accordance with the standard Geltende Norm
1-12	1	do zabawy na zewnątrz for outdoor playing zum draußen Spielen	PN-EN 1176-1:2017
NOVUM Sp. z o.o. Sp. k. ul. Bolesława Chrobrego 1, 12-100 Szczytno		e-mail: <a href="mailto:biuro@novumedukacja.pl">biuro@novumedukacja.pl</a>	<a href="http://www.novumedukacja.pl">www.novumedukacja.pl</a>
NOVUM Sp. z o.o. Sp. k. ul. Bolesława Chrobrego 1, 12-100 Szczytno		e-mail: <a href="mailto:eksport@novumgrom.com">eksport@novumgrom.com</a>	<a href="http://www.novum4kids.com">www.novum4kids.com</a>
-	-	-	-
-	-	-	-

**UWAGA / WARNING / ACHTUNG / ATTENTION:**

**PL** Jeżeli w zestawie występuje zjeżdżalnia, zestaw należy posadawić w taki sposób, aby ślizg zjeżdżalni znajdował się od strony północnej, czyli od strony nienasłonecznionej, aby zapobiegać nadmiernemu nagrzewaniu się ślizgu.

**ENG** If there is a slide in the set, it should be installed from the north, poorly sunny side to avoid possible hazards (burns) through direct skin contact.

**DEU** Wenn eine Spielplatzanlage eine Rutsche enthält, sollte diese Anlage so platziert werden, dass die Rutsche sich auf der Nordseite befindet, dh. auf der schattigen Seite, um übermäßige Erwärmung der Rutschbahn zu vermeiden.

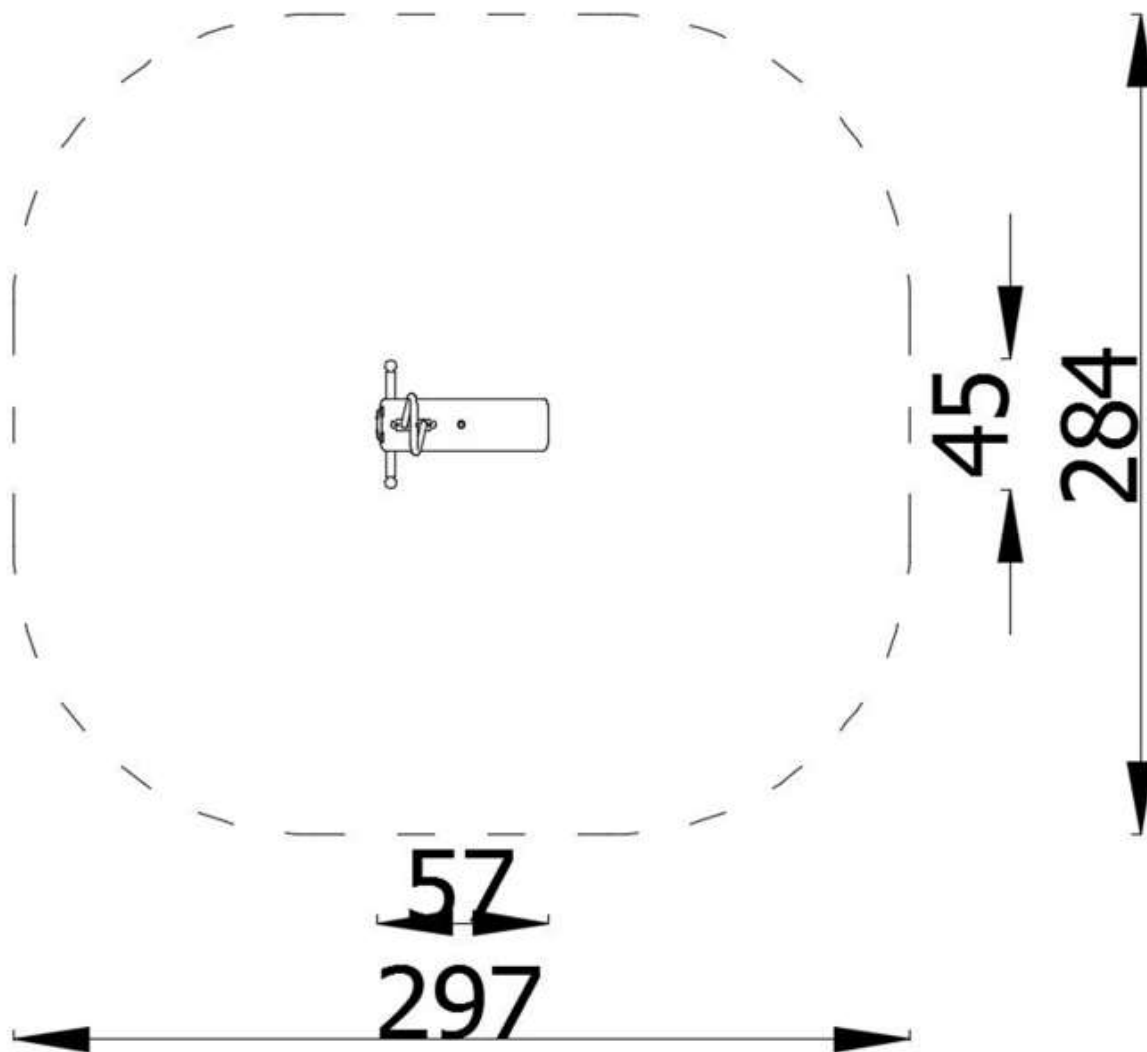

Montaż zgodnie z planem zagospodarowania terenu.  
 Installation in accordance with the land development plan.  
 Montage gemäß dem Flächennutzungsplan

Bezpieczna nawierzchnia / Safe surface / Safe Oberfläche / Surface sûre

Strefa Zone Zone Zone	Max. wysokość upadku Max. fall height Max. Fallhöhe Max. hauteur de chute	Pole powierzchni Surface area Fläche Surface	Obwód strefy bezpiecz. Perimeter security zone Umkreis der Fallschutzfläche Zone de périmètre de sé.
A	0,60 m	7,60 m <sup>2</sup>	10,50 m
B	-	-	
C	-	-	

Nawierzchnia / Safe surface / Fallschutzbelag / fr		30111
	Materiał Material Material	Min. wysokość warstwy Min. layer thicknesses Min. Schichtöhe
$h \leq 0,6$ m	Beton / Concrete / Beton Nawierzchnia bitumiczna / Bituminous surfacing / Bituminöse Oberfläche	
$h \leq 1$ m	Gleba / Topsoil / Boden Darń / Turf / Grasnarbe	
$h \leq 2$ m	Kora / Bark / Borke	20÷80 mm
	Wióry / Wood chips / Holzhackschnittel	5÷30 mm
	Piasek / Sand / Sand Żwir / Gravel / Kies	0,25÷8 mm
$h \leq 3$ m	Kora / Bark / Borke	20÷80 mm
	Wióry / Wood chips / Holzhackschnittel	5÷30 mm
	Piasek / Sand / Sand Żwir / Gravel / Kies	0,25÷8 mm
$h \leq 3$ m	Nawierzchnia syntetyczna / Synthetic granulates / Synthetische Oberfläche	wg danych producenta acc. to the manufacturer's data nach Angaben des Herstellers

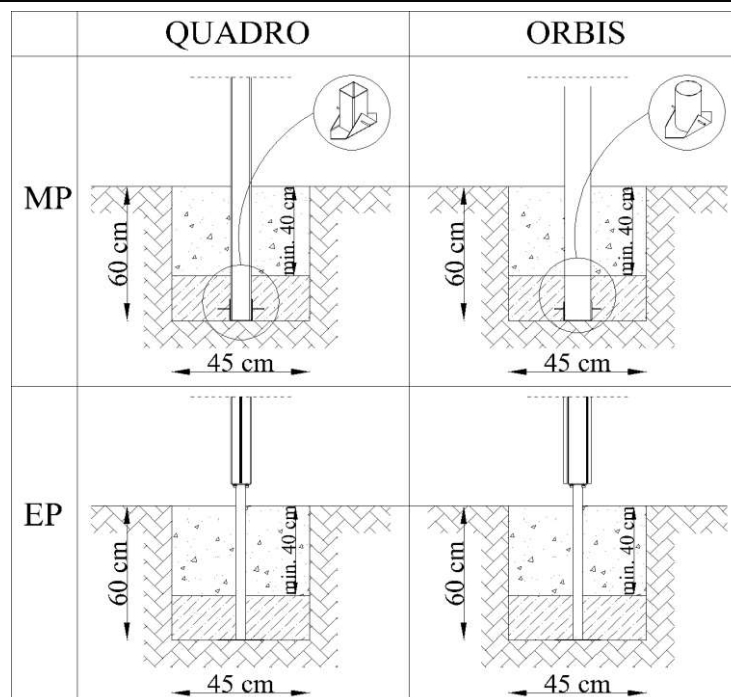

Posadowienie / Foundation / Gründung / Fondation	30111
--	-------

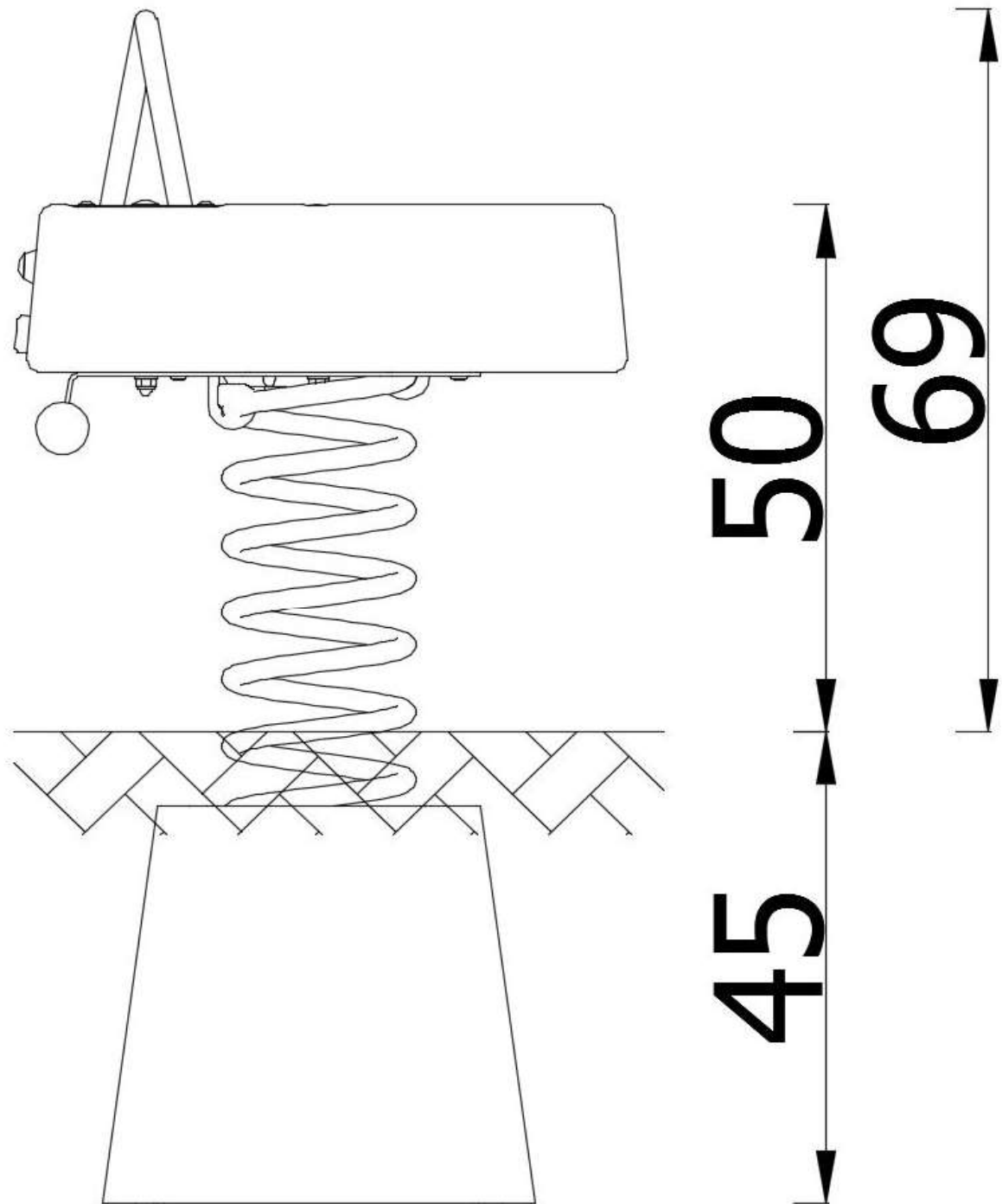

Beton / Concrete / Beton: **C16/20 - 0,07 m<sup>3</sup>**

W celu kontroli fundamentów należy usunąć nawierzchnię bezpieczną / piasek / żwir etc.  
 In order to control the foundations, remove the safe surface (sand, gravel, etc.)  
 Um die Fundamente zu überprüfen, entfernen Sie den Fallschutzbelag: Sand/ Kies etc.

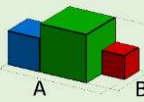
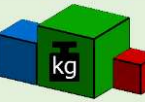
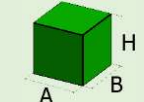

	<p>57 x 0,45 x 0,6 (AxBxH) [m]</p>		<p>128 kg</p>		<p>0,6 x 0,6 x 1,2 (AxBxH) [m]</p>		<p>128 kg</p>
---	--	---	---------------	---	--	---	---------------

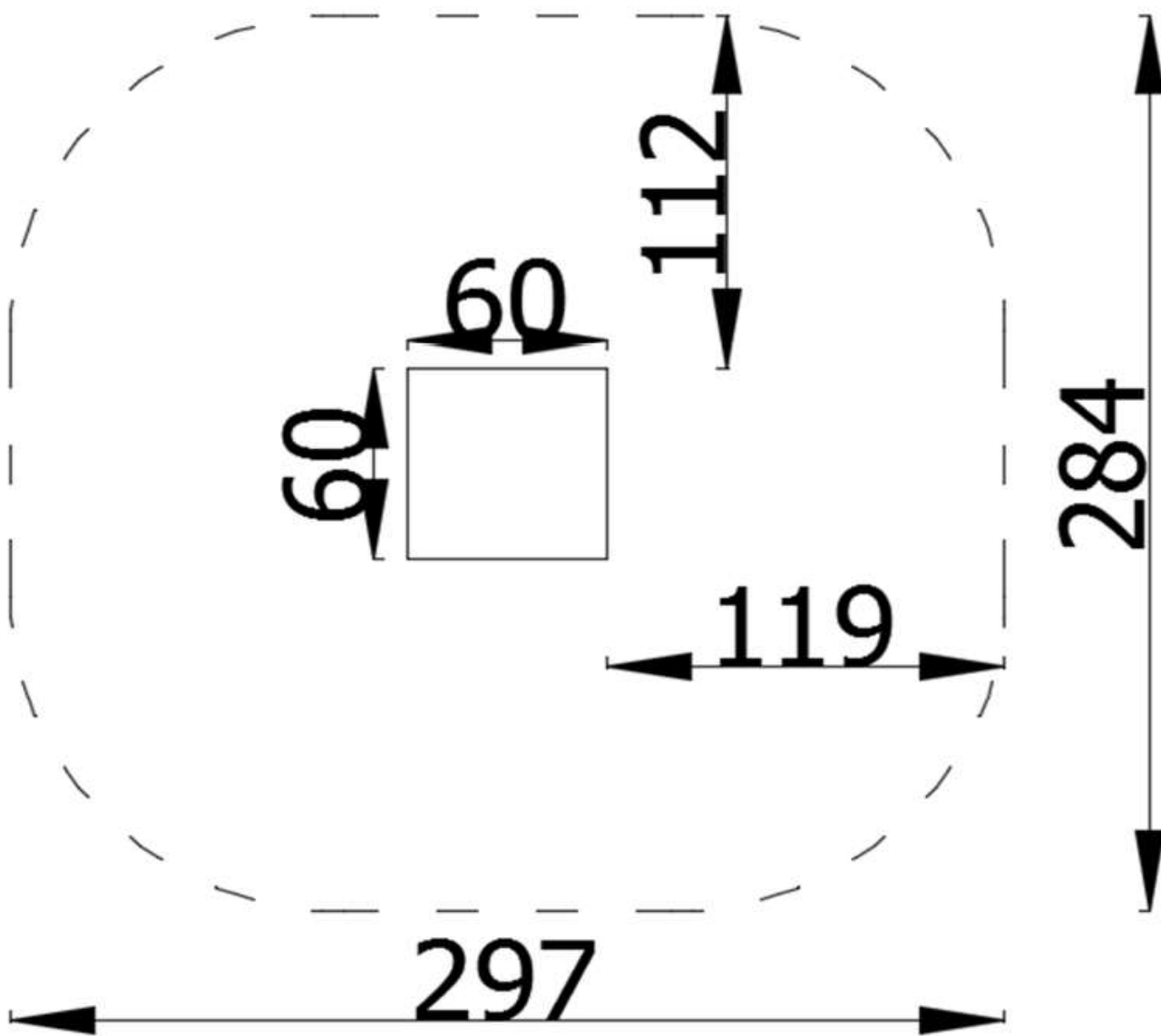

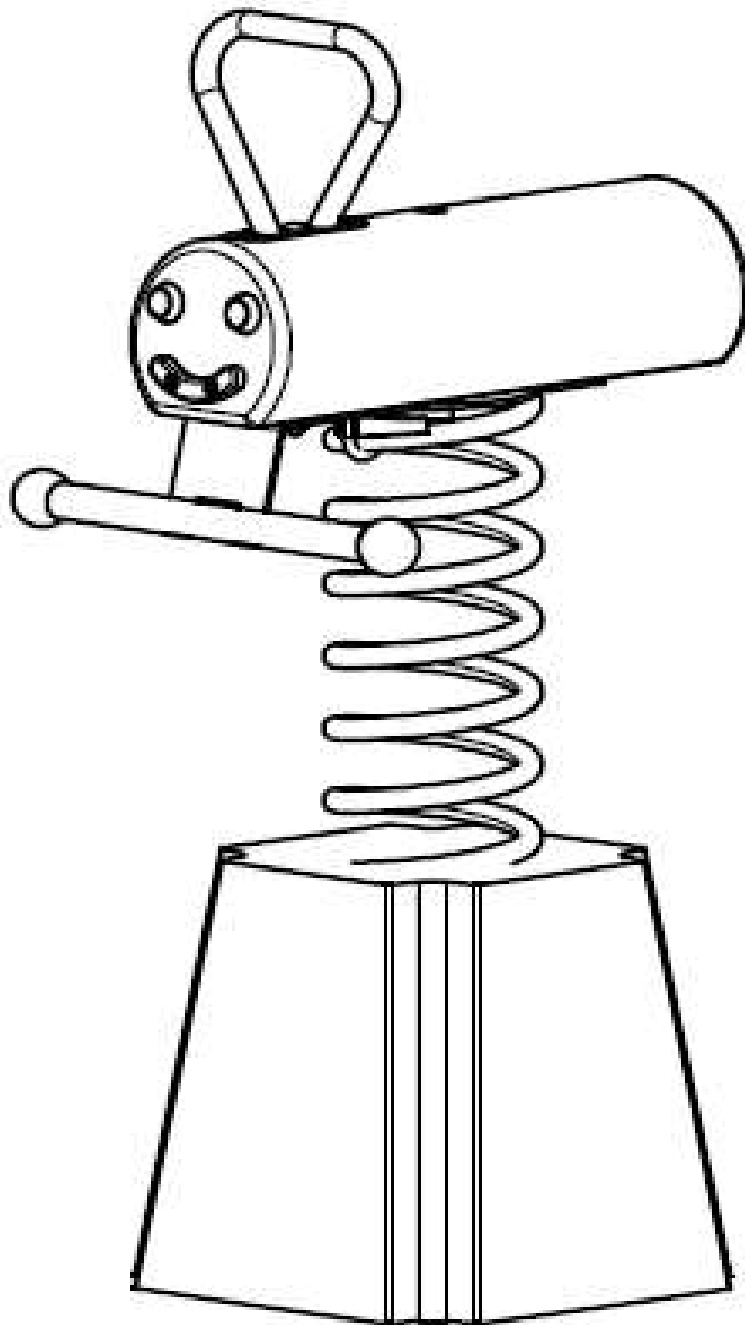















Części zamienne dostępne u producenta. Stosować klej do gwintów w połączeniach śrubowych.  
 Spare parts available from the manufacturer. Use thread glue in screw connections.  
 Ersatzteile beim Hersteller erhältlich. Gewindekleber für Schraubverbindungen verwenden.

1	Robak Robinio		30111	1			
Lp.	No.	Nazwa części	Part name	Nr części	Part No.	Ilość	Quantity
Art. Nr.	Rep.	Teilename	Nom de la pièce	Teile-Nr	Partie No.	Anzahl	Nombre

Narzędzia / Tools / Handwerkzeug / Outils

30111

															
								5 m	30 m						
															
2,5 m				60 cm	100 cm										
															
				7 mm								13 mm	17 mm	19 mm	24 mm
															
13 mm	17 mm	19 mm	24 mm	4 mm	5 mm	6 mm	8 mm	T40				T45			
